

### Automatic metal-edge filters

### AF 72 G

with radial scraper cleaning  
Connection size G1 1/2, flange DN 40

#### 1. Short description

MAHLE automatic metal-edge filters are suitable for all applications where low or high-viscosity liquids or pastes have to be filtered and homogenised.

These compact inline filter systems can be designed for semi or fully automatic cleaning. The system is cleaned by rotating the cartridge against a spring actuated scraper.

#### Advantages:

- Extended filter service life due to the use of a cleanable element
- Cleaning is possible without interrupting filtration
- Precise separation quality in accordance with the metal-edge principle
- Sturdy cartridge made of triangular stainless steel wire on a rugged core element
- Efficient filter cleaning assures maximum process stability
- Solid construction and high-quality materials for a long service life
- MAHLE modular Vario system for optimum filter selection
- Material variants open up a wide range of applications
- Gastight shaft seals available optional
- Application in Ex zone 1 and 2 optional
- Easy maintenance
- Worldwide sales



## 2. Operating principles

The MAHLE AF 72 G metal-edge filter belongs to the small Vario series. The MAHLE metal-edge filter system is used to filter and homogenise a wide range of liquids and pastes.

This compact, inline filter system consumes no filter material, which means there is also no need for subsequent disposal. The filter can be cleaned either automatically or semi-automatically without interrupting operation. The concentrated solids are drained off simply by opening the system for a short time.

The medium to be cleaned is guided into the filter housing under pressure or in suction mode. It flows inward through the MAHLE cartridge. The solids are separated on the surface of the triangular cartridge wires. The filtered fluid exits the filter housing at the top opposite the inlet connection.

The filter is cleaned either when a preset differential pressure limit is reached or after a specified cycle time elapses. The MAHLE cartridge is rotated against a spring actuated scraper for this purpose. The special cartridge gap geometry guarantees efficient cleaning.

The particles or agglomerates are skimmed from the surface and settle in the collection cone. The patented cartridge bearing (AKF system) prevents high axial forces and facilitates the cleaning process.

The residue that has settled in the collection cone can be emptied via the drain valve either when the machine is at a standstill or during filtration.

### Used MAHLE filter cartridges in the AF 72 G metal-edge filter:

#### MAHLE coiled cartridge (standard):

- Optimum cleaning by means of sharp-edged triangular wire
- High free surface portion
- Small, precise gap widths
- High differential pressure stability and torsional strength
- Several material combinations possible

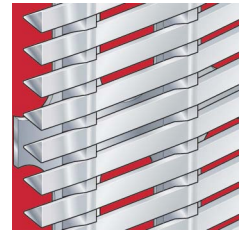

#### MAHLE welded cartridge:

- High wear resistance to abrasive media
- Sturdy trapezoidal wire for high-viscosity media
- Welded design
- Manufactured in stainless steel

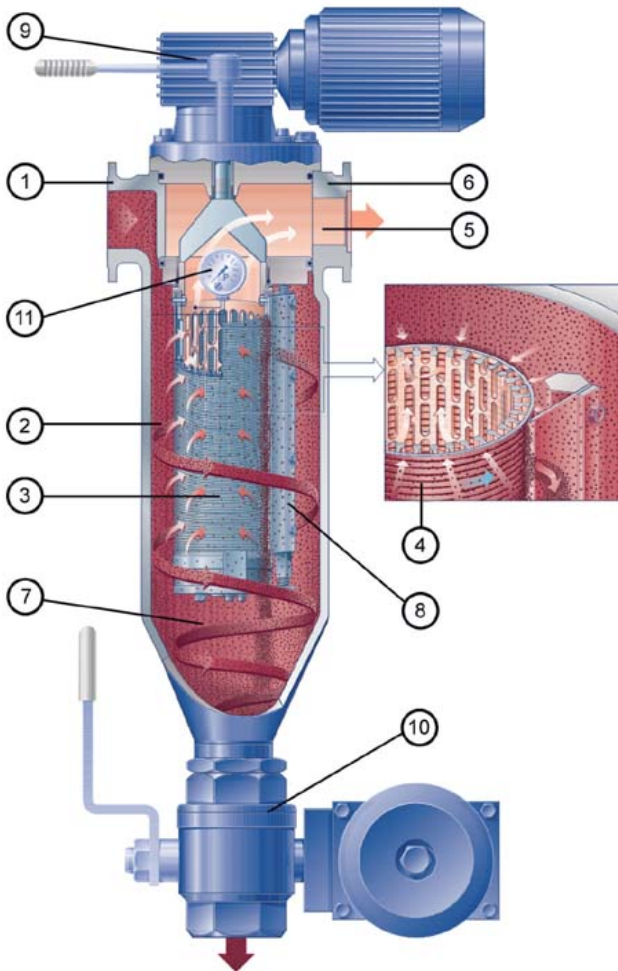
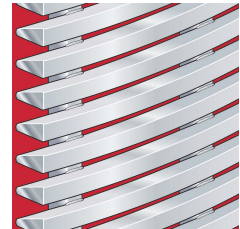

- 1 Inlet connection
- 2 Inlet plenum
- 3 MAHLE cartridge
- 4 Triangular wire winding
- 5 Plenum for filtered fluid
- 6 Outlet connection
- 7 Particle collection cone
- 8 Scraper
- 9 Cleaning drive with gear motor or hand ratchet
- 10 Drain valve (automatic or manual)
- 11 Differential pressure indicator/switch

### 3. Technical data

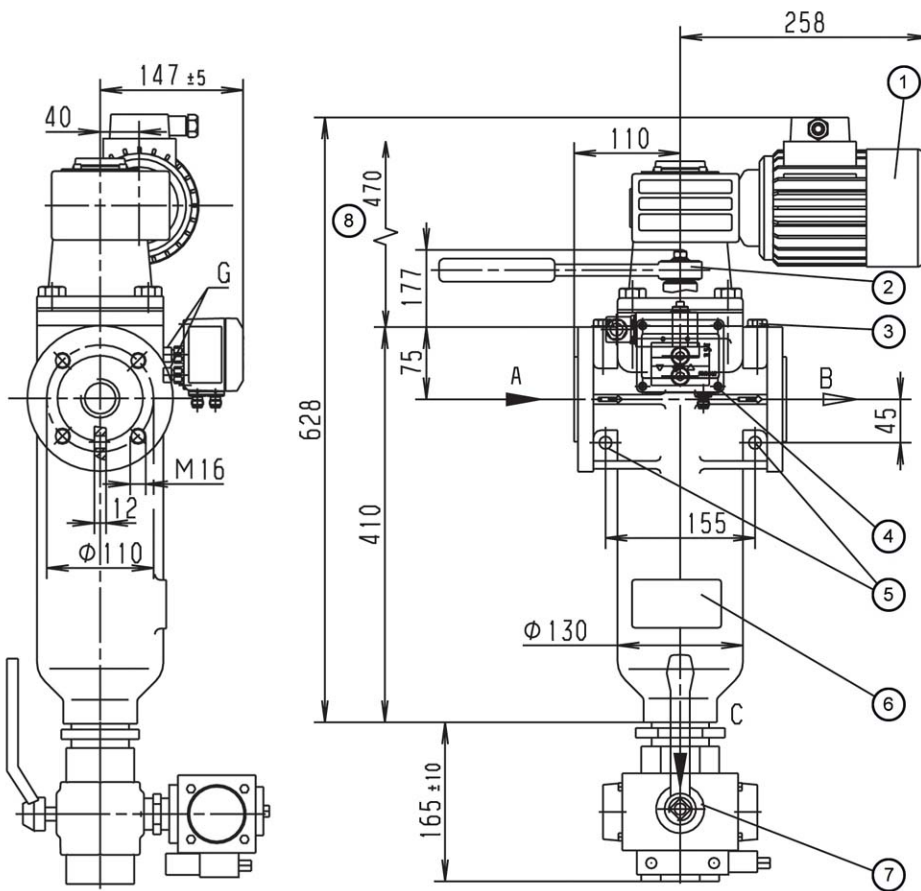

- 1 Cleaning drive, worm gear motor can be mounted at each 90° position
- 2 Optional ratchet
- 3 Vent screw G1/4
- 4 Optional differential pressure indicator/switch
- 5 Mounting holes Ø13
- 6 Name-plate
- 7 Optional drain valve, manual or automatic mode
- 8 Clearance required = 470 mm

#### Filter data

- Max. operating pressure: - 16, 40, 63 bar  
 - 100 bar only permitted with static load
- Max. operating temperature: - 200 °C up to 63 bar  
 - 100 °C up to 100 bar
- Materials: - Housing and cover: Nodular cast iron 40  
 - Internals: Nodular cast iron, steel, optional stainless  
 - Optional interior coat  
 - Bearing bushes: PTFE based  
 - Seals: FPM (Viton)  
 - Coiled cartridge: Al, 1.4571 (Δp max. 40 bar)  
 - welded cartridge: 1.4571 (Δp max. 10 bar)
- Cover lock: 4 x M16 hexagon screws
- Connect./nominal diam.: - A-inlet, B-outlet: G1½, flange DN 40  
 - C-drain: G2, G-Δp-connection: G1/8  
 All threaded holes acc. to DIN 3852 form X; flanges acc. to EN 1092-1/11B1/PN 40
- Drive shaft seal: Gland packing rings made of PTFE fibre with disc spring pre-tension; optional lip seal with O-ring
- External finish: Synthetic resin primer, blue (RAL 5007)

#### Motor data

Worm gear motor  
 Multi-range winding

V	Hz	kW	rpm	A
Δ 230 ± 10%	50	0.18	17	1.2
λ 400 ± 10%	50	0.18	17	0.7
Δ 266 ± 10%	60	0.22	21	1.2
λ 460 ± 10%	60	0.22	21	0.7

Protection class: IP55, insulation class F; output torque: 52 Nm

#### Optional: Ex protection acc. to Atex 94/9/EC

- Electrical design in Ex II 2G T3
- Mechanical design in Ex II 2G c T3

Weight: 42 kg (with ratchet) or 52 kg (with motor)

Volume: 4 l

#### Other types available on request!

**Technical data is subject to change without notice!**

## 4. Design and application

Cartridge type (see section 6)	Total surface in cm <sup>2</sup>	Gap width in µm/ effective gap surface in cm <sup>2</sup>														
		30	40	50	60	80	100	130	160	200	250	360	500	1000	1500	2000
AF 6014	437	26	34	42	49	63	76	94	111	131	152	191	229			
AF 6024	437			27	32	42	51	64	76	91	109	142	176	254	298	327
AF 6034	419	25	33	40	47	61	73	91	106							
AF 6044	419			26	31	40	49	61	73	88	105	136	169	244	286	314
AF 6064	415									44	53	73	95	156	198	229
AF 6074	415			21	25	32	40	50	60	73	87	115	145			
AF 6084	415			27	32	42	51	64	77							

 recommended design

### Cleaning and emptying

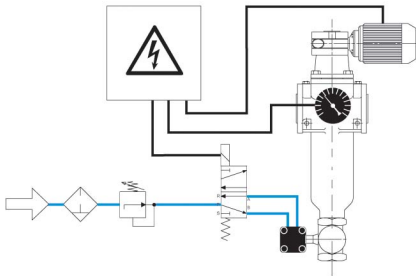

#### Fully automatic operation:

Filtration usually takes place under pressure. The filter is cleaned after a programmed time or a preset number of cycles or according to the differential pressure. We recommend cleaning the system at approximately 4 times the initial differential pressure. The cleaning motor is operated for around 10 seconds (about three turns of the cartridge). This is sufficient to clean the filter thoroughly. The motor may need to run continuously in exceptional cases. The drive shaft is always turned clockwise.

The drain valve is opened in order to empty the filter. Depending on the residue concentration, this can either take place synchronously with cleaning or be time or cycle controlled.

The opening time of the drain valve can be set between 2 and 6 seconds. The filter can be emptied in suction mode using a buffer or by interrupting the filtration process.

Semi-automatic and manual operation are also possible.

Refer to the Instruction Manual for further information.

## 5. Performance curves

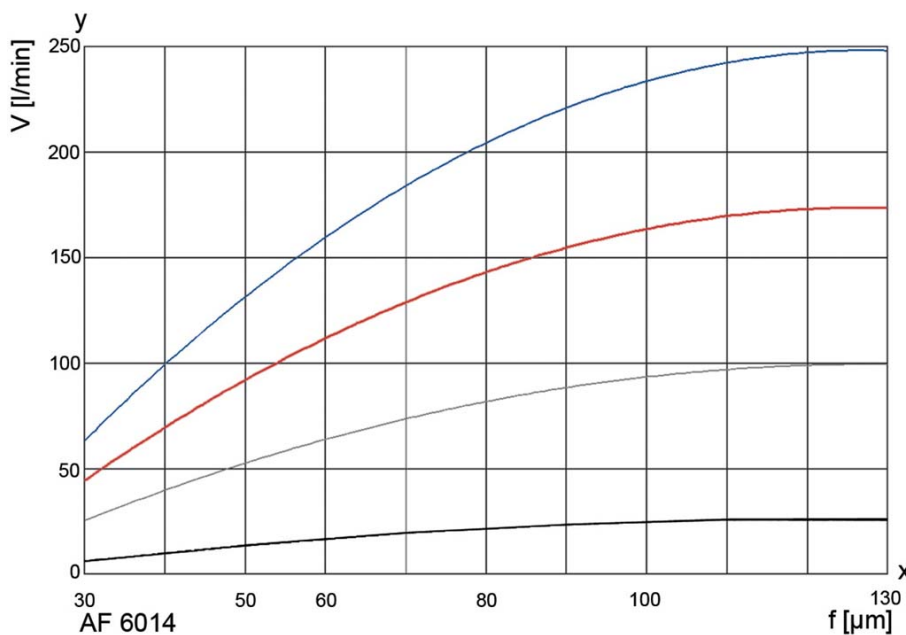

The curves indicate the volume flow through the complete filter system (filter housing including cartridge) and are referred to a differential pressure of 0.3 bar. Specific process information is essential to guarantee reliable operation of an automatic filter.

Viscosity in mm<sup>2</sup>/s (cst)

-  1 mm<sup>2</sup>/s
-  33 mm<sup>2</sup>/s
-  100 mm<sup>2</sup>/s
-  500 mm<sup>2</sup>/s

y = Volume flow V [l/min]

x = Gap width f [µm]

mm<sup>2</sup>/s = cst

## 6. Type number key

### Type number key with selection example for AF 7243-221-40200/G4

#### Size

AF 724 1x 65x230 No. of steps x diameter x length [mm]

#### Cleaning drive

- 2 Ratchet
- 3 Gear motor 230/400 V, 50 Hz or 266/460 V, 60 Hz
- 4 Gear motor 230/400 V, 50 Hz Ex II 2G T3

#### Inlet and outlet connections

- 2 DN 40 with G1½

#### Permissible operating pressure in bar (housing/cover)

- 2 PN 16
- 4 PN 40
- 5 PN 63
- 6 PN 100

#### Material Seal FPM, bearing PTFE

- 1 Housing and cover nodular cast iron, steel, aluminium
- 3 Housing and cover steel, grey cast iron or nodular cast iron, internals stainless steel 1.4301/1.4571
- 4 Housing and cover steel, grey cast iron or nodular cast iron, aluminium-free
- 6 Housing and cover nodular cast iron with delta seal coating, internals stainless steel 1.4301

#### Differential pressure indicator and switch

- 1 PiS 3076, switching level at 1.2 bar, static 63 bar, aluminium/FPM
- 2 PiS 3076, switching level at 0.7 bar, static 63 bar, aluminium/FPM
- 4 PiS 3170, digital  $\Delta p$  gauge, 2 switching levels settable from 0 to 16 bar
- 8 PiS 3076, switching level at 2.2 bar, static 63 bar, aluminium/FPM
- 9 PiS 3076, switching level at 5 bar, static 63 bar, aluminium/FPM

#### Valves and control throttles

- 0 Without/special version

#### Drain valve

- 1 Ball valve, manual
- 2 Ball valve, electropneumatic 24 V
- 3 Ball valve, electropneumatic 230 V
- 4 Ball valve, electric 24 V
- 5 Ball valve, electric 230 V

#### Cleaning valve

- 0 Without/special version

#### Optional features

- 1 Bypass valve 20 bar
- 2 Bypass valve 40 bar

AF 724 3 -2 2 1 -4 0 2 0 0 -XXXX (end number for special version)/G4

End number	Special version
3001	Standard filter insert (complete), without housing or drive
3002	Standard filter insert (complete), without housing, with drive
3700	PTFE seals
Other numbers	On request

Type number key with selection example for coiled or welded cartridges for AF 60

Series						/E1
AF 60 Coiled or welded cartridge with triangular wire winding						
	<b>Material</b>	<b>Core element</b>	<b>Filter medium</b>	<b>Clamp rings</b>	<b>Wire width in mm</b>	
<b>coiled cartridge</b>						
	1	Al	1.4571	1.4571	0.5	
	2	Al	1.4571	1.4571	0.8	
	3	1.4581	1.4571	-	0.5	
	4	1.4581	1.4571	-	0.8	
<b>welded cartridge</b>						
	6	-	1.4571	1.4571	1.8	
	7	-	1.4571	1.4571	1	
	8	-	1.4571	1.4571	0.75	
<b>Overall length</b> Diameter x length in mm						
	4	65x230				
<b>Gap width/rating in µm (see 4. Design and application)</b>						
	<b>003</b>	30 µm	<b>010</b>	100 µm	<b>036</b>	360 µm
	<b>004</b>	40 µm	<b>013</b>	130 µm	<b>050</b>	500 µm
	<b>005</b>	50 µm	<b>016</b>	160 µm	<b>100</b>	1000 µm
	<b>006</b>	60 µm	<b>020</b>	200 µm	<b>150</b>	1500 µm
	<b>008</b>	80 µm	<b>025</b>	250 µm	<b>200</b>	2000 µm
Other filter ratings on request						
AF 60	1	4	- 010			/E1

## 7. Spare parts

No.	Designation	Order number	
		FPM/C steel	PTFE/VA
1	Bush kit		79725557
2	Set of seals (complete)	79331786	79718511
3	Scraper		79718503
4	Cartridge	See name-plate	

Please contact us for detailed technical information, any open questions about options, accessories and for general expert advice. Completion of the relevant questionnaire would facilitate in the coordination of all important parameters.

Comprehensive documentation on our filter range, filter elements and accessories can be provided. About installation and operation, please refer to the Instruction Manual.

MAHLE Industriefiltration GmbH  
 Schleifbachweg 45  
 D-74613 Öhringen  
 Phone +49 (0) 7941/67-0  
 Fax +49 (0) 7941/67-23429  
 industrialfiltration@mahle.com  
 www.mahle-industriefiltration.com  
 79753906.03/2011